

LED Wall Sconce

WS25125
INSTALLATION SHEET

START FROM HERE

- Make sure **POWER** is **COMPLETELY OFF** at the fuse box
- Have your fixture installed by a qualified licensed electrician
- Prepare everything in a clear area
- Wear gloves at all time during this installation
- Read instructions carefully before you start assembly
- Keep this installation sheet for future reference

Technical Support: 1-855-855-8926

Please Note:

- This Kuzco LED fixtures come with pre-wired LED module(s)
- Unless instructed, Do Not touch any part of the LED module(s) as any unnecessary contact with the module could cause permanent damage
- Use ELV (Electronic Low Voltage) or TRIAC type of dimmer for dimming application

- 1.** Remove fixture from its original package
- 2.** Separate canopy (2a) from fixture body (3a) by loosening set screws with allen key (2b)
- 3.** Separate mounting plate (1c) from canopy (2a) by removing screws (1g)
- 4.** Attach mounting plate (1c) to electrical junction box (1a) using screws provided (1e) in hardware package
- 5.** Attach canopy (2a) to mounting plate (1c) and secure with screws (1g)
- 6. Optional Single Gang Box Installation:** Attach mounting plate (1j) to electrical junction box (1a) using screws provided (1e) in hardware package
- 7.** Make proper electrical connections (black to hot "L", white to neutral "N", ground to "GND") with wire nuts (1b) provided in hardware package
- 8.** Attach fixture body (3a) to canopy (2a) or mounting plate (1j) and then secure with set screws with allen key (2b)
- 9.** Slight turn when inserting lamp head (3c) into socket on fixture body (3a)

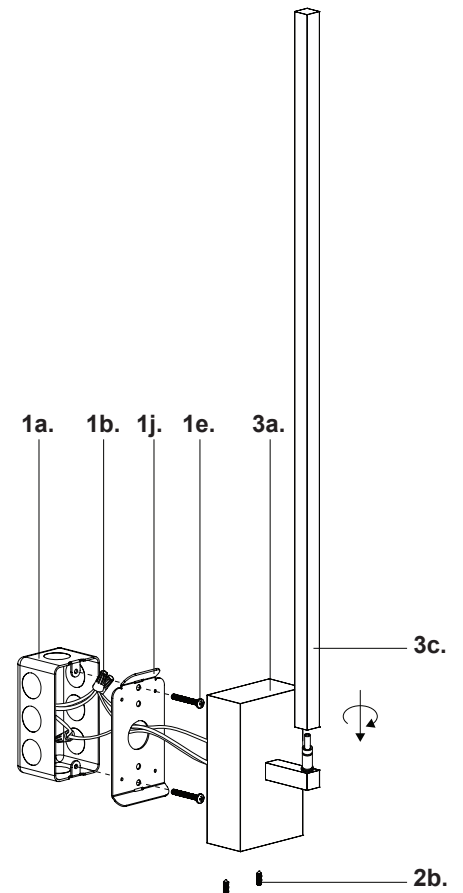
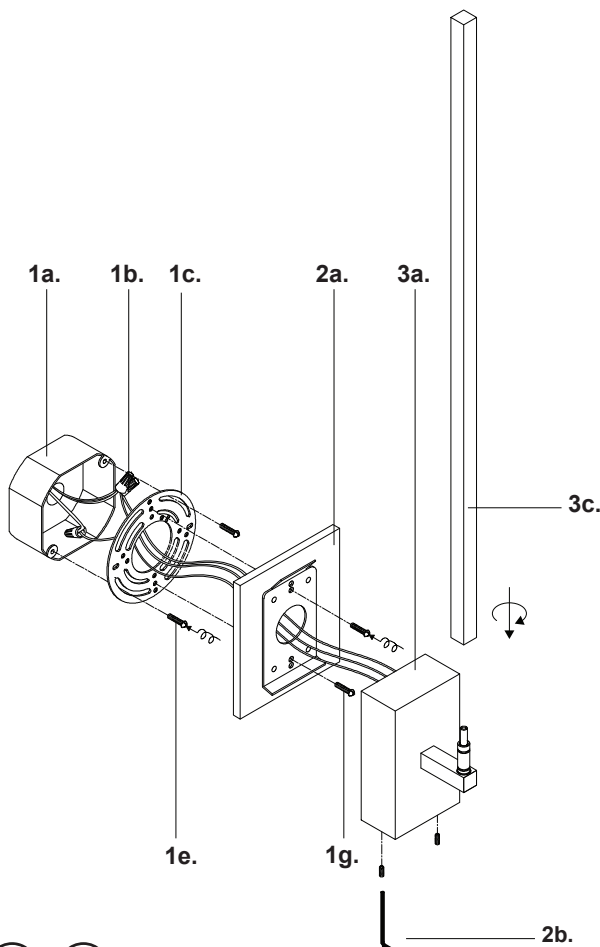

KUZCO

19054 28th Avenue Surrey, BC Canada V3Z 6M3
T: 604 538 7162 TF: 1-855 85 KUZCO F: 604 538 7196
W: kuzcolighting.com
20240515