

Customer Service : (702)361-4345, (800)525-2655, customer.service@kalco.com

WARNING - TO REDUCE THE RISK OF FIRE OR INJURY:

1. If you are unfamiliar with electrical wiring, call a qualified electrician to install this unit. More than one person may be necessary to install fixture, make sure you have enough qualified help.
2. Turn off the power to the fixture's circuit at the service panel. Use a voltage detector to verify that the power is off.
3. DO NOT install bulb which exceeds the maximum wattage specified on the socket label.

FRAME INSTALLATION

Step 1. Fix fixture crossbar 2 to outlet box 1 with original outlet box screws. Mark top and bottom cross bar slots in the wall, remove crossbar then install anchor screws in the wall.

Step 2. Screw Crossbar 2 to outlet box 1 with original outlet box screws. Make sure crossbar studs are pointing away from wall. Reinforce cross bar with top and bottom anchor screws.

Step 3. Get fixture frame a few inches close to wall and connect wires: Connect fixture ribbed wire (L) to power supply black wire. Connect fixture smooth wire (N) to power supply white wire. Connect fixture silver or copper bare wire (G) to power supply green wire.

Step 4. Align fixture back plate holes to crossbar studs 2 and fix it flat to wall, secure fixture with decorative nuts 5, then install light bulbs.

Step 5. Install threaded rod 7 to bottom of fixture, then install parts 8, 9, 10, and 11.

Proceed to install crystal set; follow directions on pages 2 and 3.

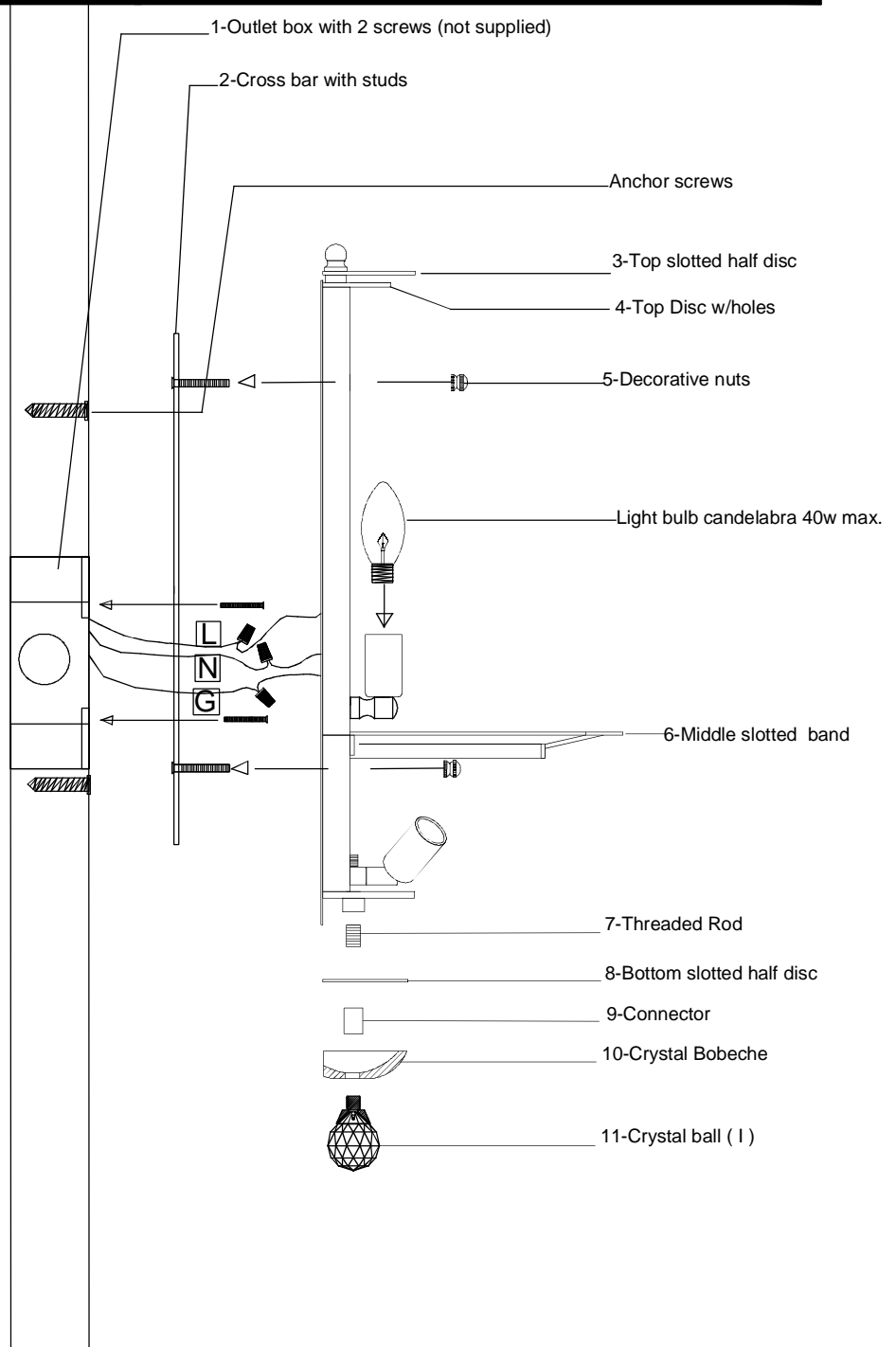

Customer Service : (702) 361-4345, (800)525-2655, customer.service@kalco.com

TRIMMING INSTRUCTIONS:

Step1. Carefully unpack all parts from carton, unwrap the crystals, lay them down on a clean soft cloth. Identify and organize crystals as shown in page 3.

Step2. Install crystal strands (C) first hung Thinner side of strand to top ring then to Middle ring.

Step3. Install crystal strands (G) first hung Thicker side of strand to Middle ring then to bottom.

Step4. Refer to fig.1B on top right and install crystals (B) to top slotted half disc 3. Then install crystal (A) following FIG.2 top view pattern.

Step5. Refer to FIG.1B on top right and start installing 2 crystals (E) on center of Middle slotted band as shown below in FIG.3

Make pattern as shown from center to right then from center to left: install 2 crystals (B) and 2 (D), then 2 (E) and 2 (D) then repeat.

Step6. Install all crystals (F) from the back and underneath of middle slotted band.

Step7. Remove parts 11, 10 and 9 to release bottom slotted half disc 8. Install crystals (H) and place it back, install back parts 9, 10, and (1).

Turn switch on.

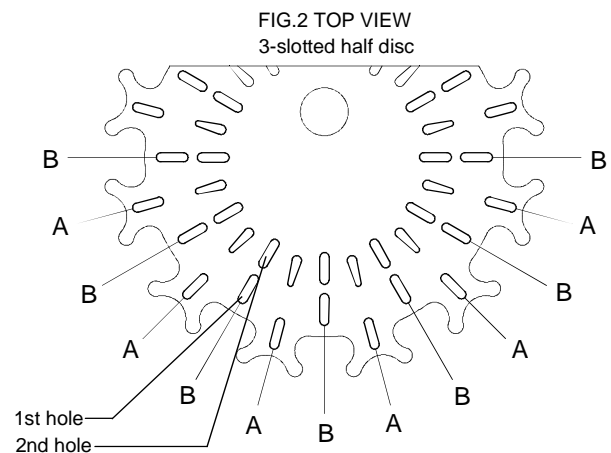
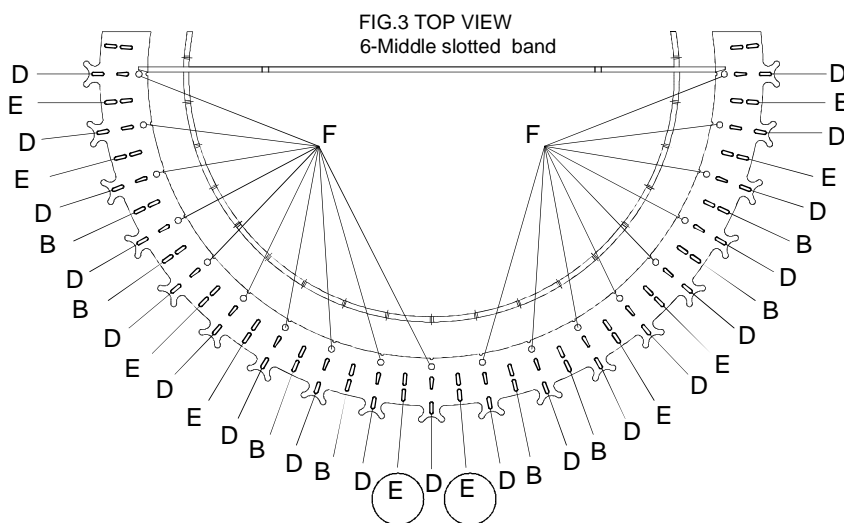
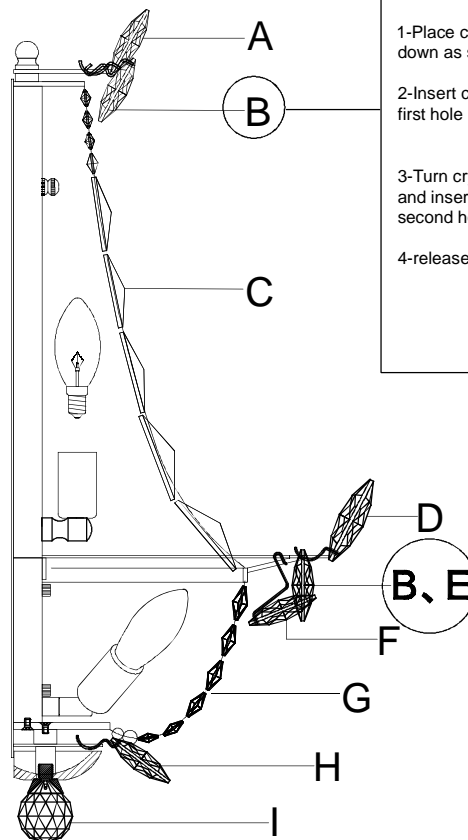
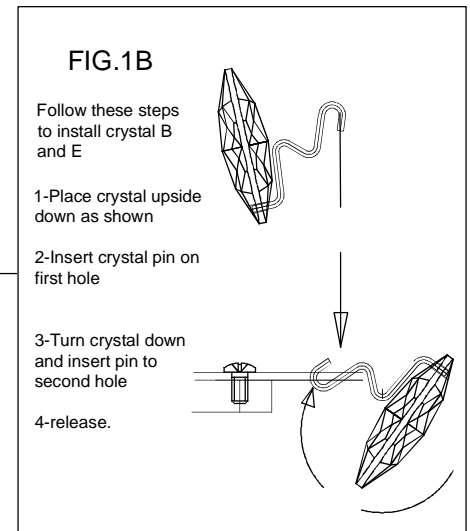

Step5. Start here.

Customer Service : (702) 361-4345, (800) 525-2655, customer.service@kalco.com

CRYSTAL DIAGRAMS

Use this diagram to identify each crystal component and to reorder replacement parts.

Code	Quantity
A	6
B	15
C	9
D	19
E	10
F	19
G	19
H	6
I	1

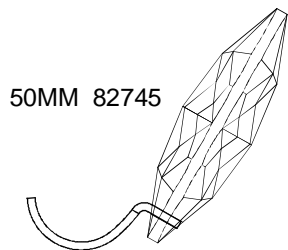

A

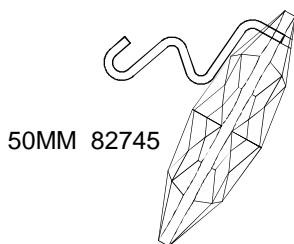

B

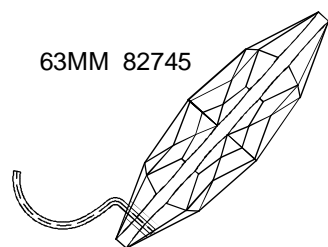

D

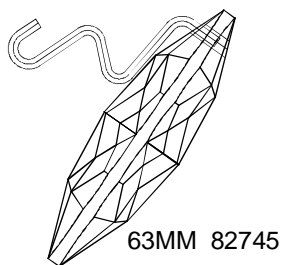

E

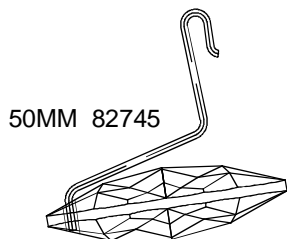

F

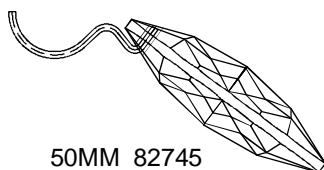

H

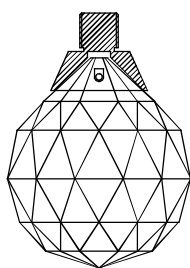

I

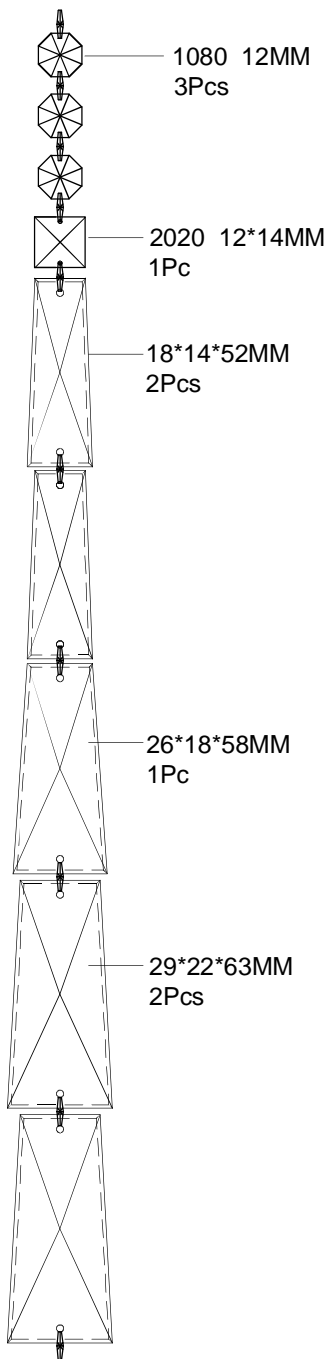

C

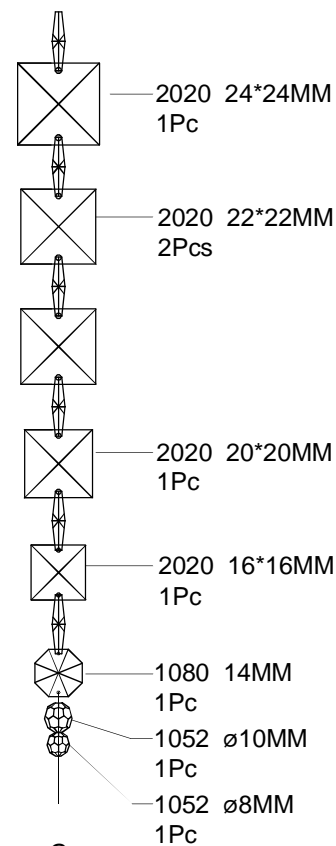

G