

ASSEMBLY INSTRUCTIONS

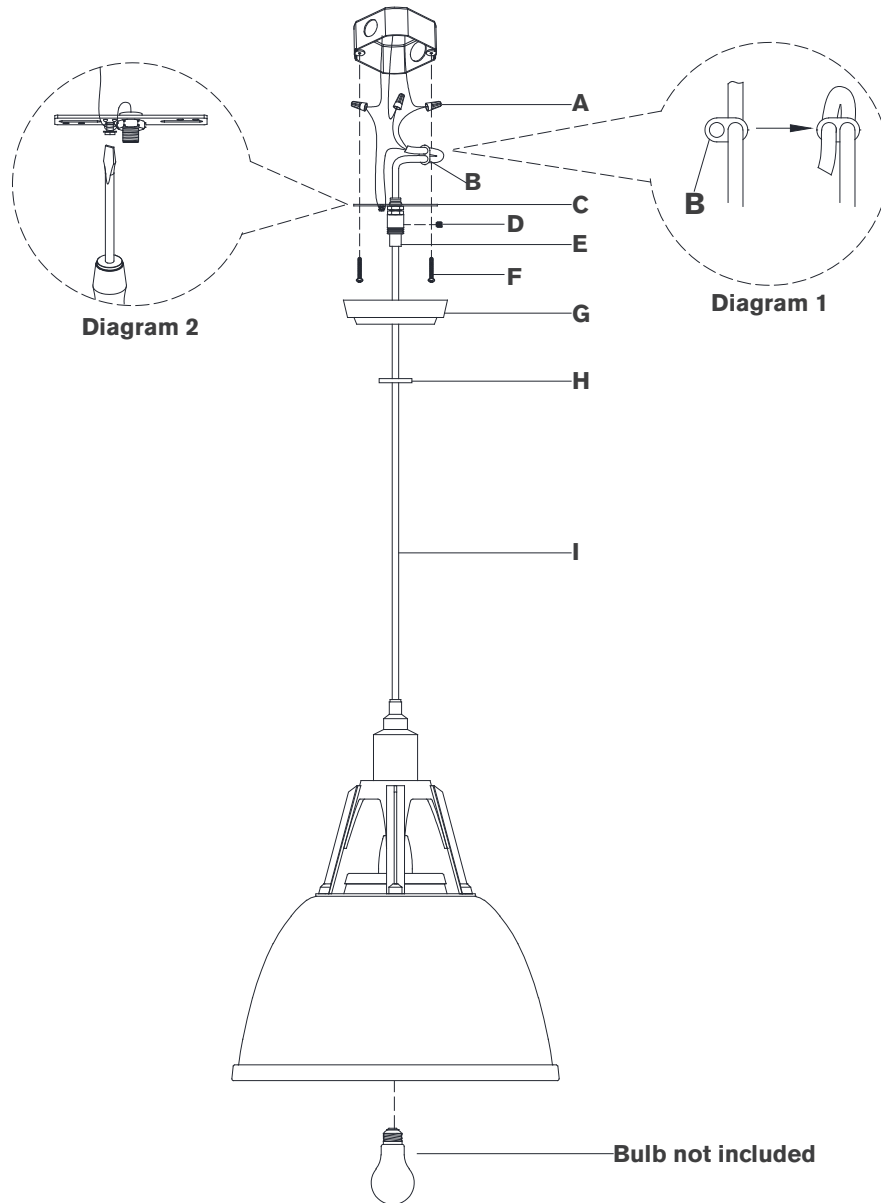

Gunner 16" Pendant

Item # TOB 5640

NOTICE:

This light fixture should be installed in accordance with all applicable, local installation codes, and by a person familiar with the construction and operation of it, as well as the hazards involved. Inspect item and contents carefully. If any damage or defect is found, do not install. Retain all packaging material until installation is complete and approved.

TOOLS REQUIRED (NOT INCLUDED):

Phillips Screwdriver Slotted Screwdriver Wire Cutters
Wire Strippers

1. Carefully remove all parts from the box. Place on a clean, soft surface.
2. Remove mounting plate (C) from canopy (G) by loosening collar ring (H).
3. Install mounting plate (C) to the junction box and secure with mounting screws (F).
4. Loosen set screw (D) on collar loop (E), then feed fixture wire through collar ring (H), canopy (G) and collar loop (E).
5. Holding fixture upright, slide collar ring (H) and canopy (G) down and rest on fixture body, then adjust wire to desired height. Tighten set screw (D).

NOTE: Make sure there is no tension on the electrical wire when fixture is fully extended.

6. Cut excess wires, being sure to leave enough to reach the junction box.

NOTE: Make sure fixture height are accurate before cutting wires.

7. Feed fixture wire through strain relief (B) as shown in diagram 1.
8. Remove outer housing of wire by making a neat cut all the way around, about 1" from the end. Make sure not to cut too deep or electrical wires could be damaged underneath. Once cut is made, remove and discard the 1" piece of housing off the end, exposing the electrical wires.
9. Separate wires, and strip insulation on each 5/8".

VISUAL COMFORT



ASSEMBLY INSTRUCTIONS

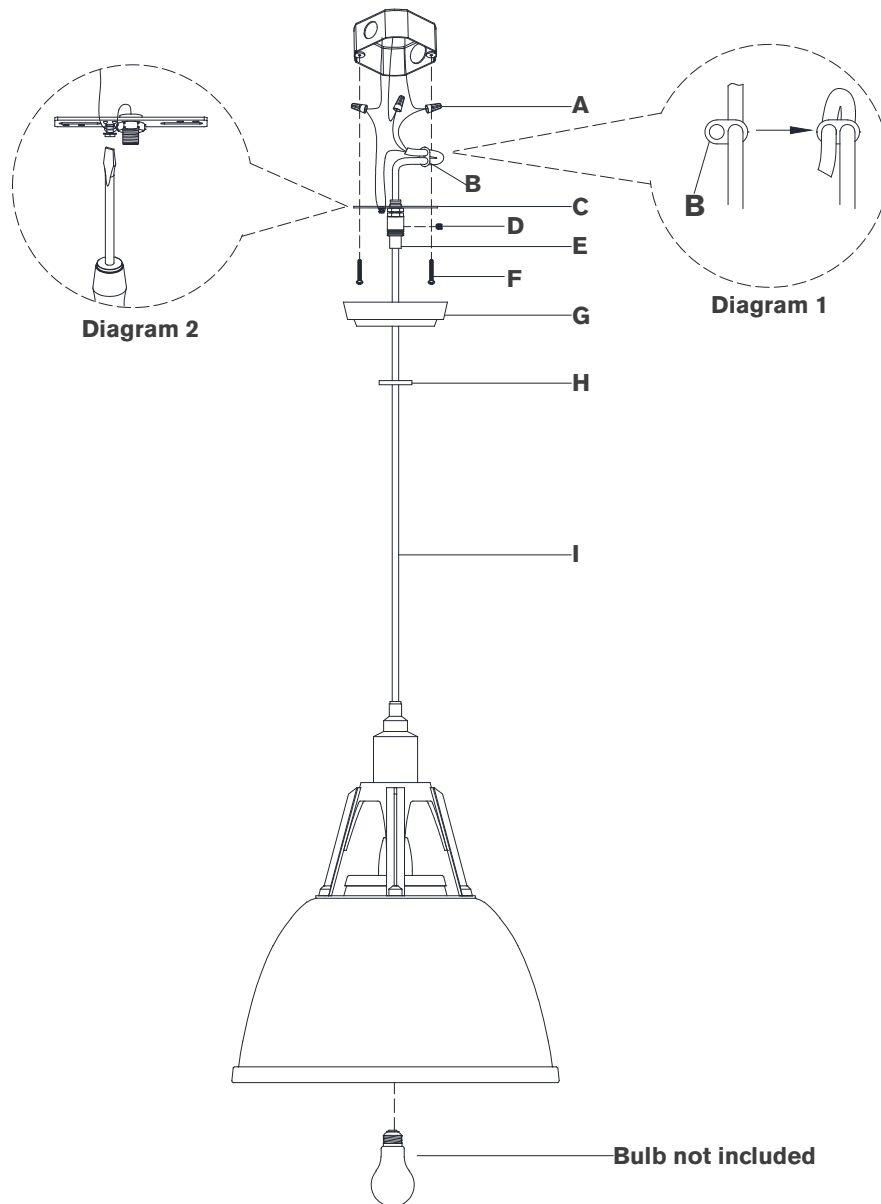

Gunner 16" Pendant

Item # TOB 5640

NOTICE:

This light fixture should be installed in accordance with all applicable, local installation codes, and by a person familiar with the construction and operation of it, as well as the hazards involved. Inspect item and contents carefully. If any damage or defect is found, do not install. Retain all packaging material until installation is complete and approved.

10. Wrap fixture ground wire (bare copper) around the green grounding screw (see diagram 2). Tighten. Continue fixture ground wire and connect to supply ground wire (usually green or bare copper) using wire nut **(A)**.

NOTE: It is imperative that the fixture is grounded.

11. Connect fixture neutral wire (white) to the supply neutral wire (usually white) using wire nut **(A)**.

12. Connect fixture hot wire (black) to the supply hot wire (usually black) using wire nut **(A)**.

CAUTION: Do not reverse the hot and neutral connections.

14. Make sure all wire connections are tight, then carefully tuck into the junction box.

15. Install canopy **(G)** to mounting plate **(C)** and secure with collar ring **(H)**.

16. Install light bulb into the socket.

Care Instructions: Clean only with a soft dry cloth or feather duster. Do Not use abrasive or chemical agents.

VISUAL COMFORT

